



mockingbird



# Let's get rolling

**Mockingbird Single Stroller**

**Expand your Stroller in a few easy steps!**

Scan the QR code for a step-by-step video tutorial on setting up and using your Mockingbird Stroller.



# Warning

Please follow all of these instructions to ensure the safety of you and your child. Keep these instructions for future reference. Failure to follow these instructions could result in serious injury or death.

Avoid serious injury from falling or sliding out. Always ensure that the child is properly positioned by using the safety harness according to these instructions.

## **Choking Hazard**

Adult assembly required because of small parts. Keep (assembly parts) out of reach of children under 3 years.

## **Caution**

- Make sure the stroller is fully erect and latched in the open and locked position before allowing children near the stroller.
- Make sure all body parts are clear of the stroller when folding and unfolding.
- Never use the stroller on stairways or escalators.
- Never use the stroller with roller skates or in-line skates.
- Never leave children unattended.
- Never allow the stroller to be used as a toy.
- Maximum user weight in the stroller seat 50lbs. Maximum user height in the stroller seat 42 inches (107 cm).
- The maximum weight that can be carried in the lower basket is 25 lbs (11.3 kg). Placing excessive weight in the unit or on the unit (e.g., purses, shopping bags, parcels, diaper bags, or accessory items) may change the balance of the stroller and cause hazardous/unstable conditions.

# First, unpack the box and make sure you've got everything

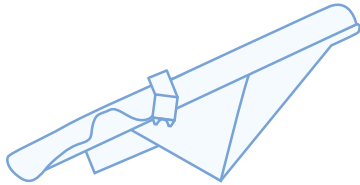

**Stroller seat**

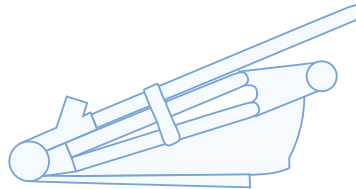

**Stroller frame**

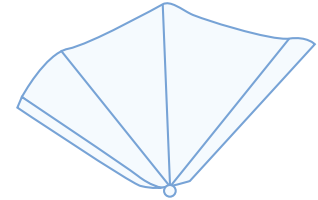

**Extendable Canopy**



**Child bar**

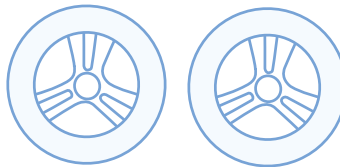

**Rear wheels**

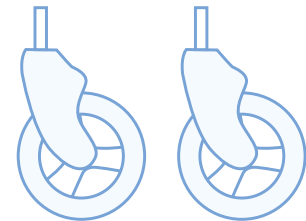

**Lock & swivel front wheels**



**Storage Bag**

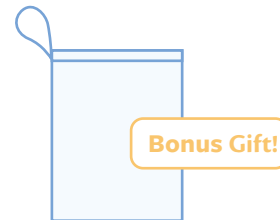

**Wetbag**

# 1

## Open the frame

### Lift up the latch

On the right side of the stroller frame, lift up on the latch to open the frame.

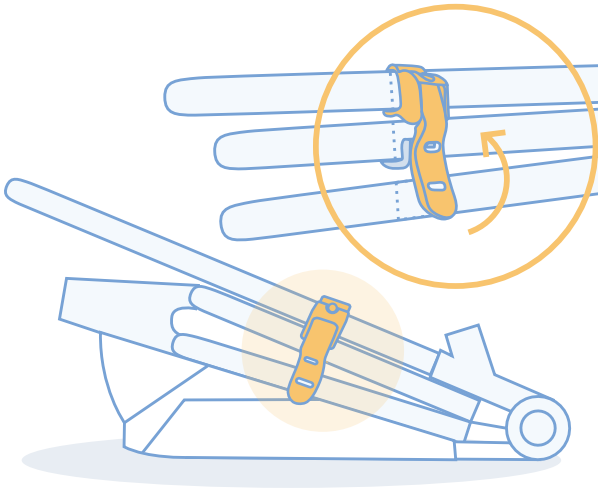

### Open the frame

Lift up on the stroller handle with both hands until the stroller frame is in a fully opened and locked position. When the stroller is fully opened, you will hear a “CLICK”.

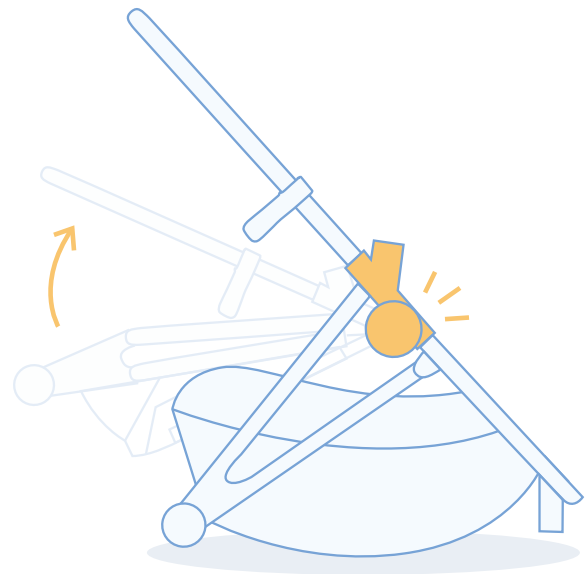

# 2

## Attach the wheels

### Attaching the front wheels

Push the front wheel post into the wheel housing until it “CLICKS” into a fully locked position. Pull on the wheel to confirm it is attached. To remove, press the metal button located on the back of the wheel housing and push inward.



Before attaching the front wheels, make sure the stroller is in a fully open position.

### Attaching the rear wheels

Push the rear wheel post into the wheel housing. Pull on the wheel to confirm it is attached. To remove, lift the white levers located on the back of the wheel housing and pull the wheel outward.

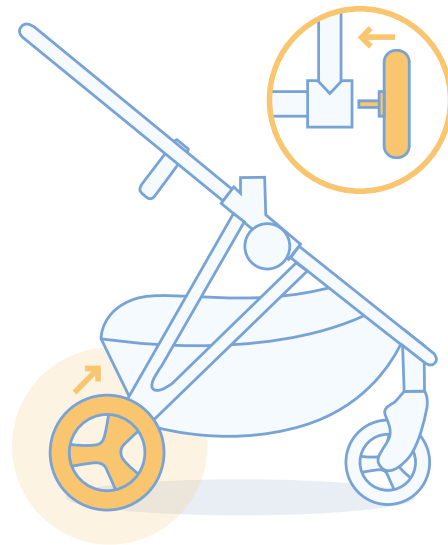

# 3

## Attach the stroller seat

Place the stroller seat into the right and left joints until it “CLICKS” into a fully locked position. Press the white buttons located on both sides of the stroller frame and lift stroller seat upward to fully remove.

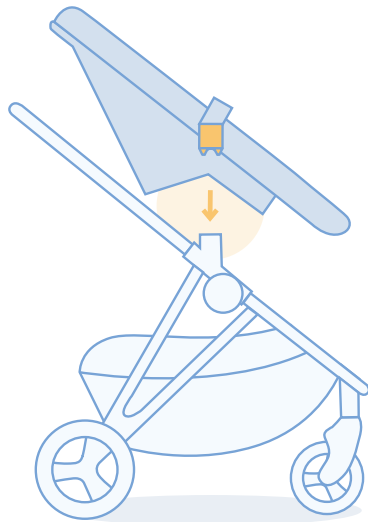

**Front facing seat**

Child faces away from parent

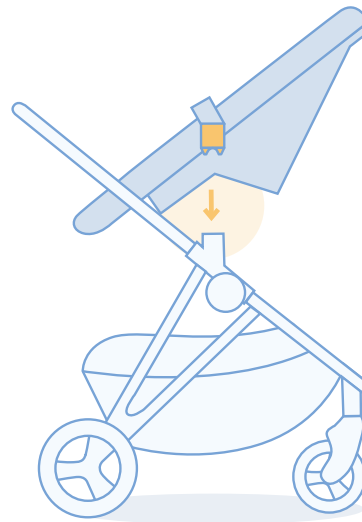

**Rear facing seat**

Child faces parent



**Important!**

Seat must be front facing to fold the stroller.



# 4

## Attach the canopy

### Attaching the canopy

Place the back of the canopy onto the top of the stroller seat over the recline latch. Slide both sides of the canopy locks into both canopy housings located on the seat frame until they “CLICK” into a fully locked position.

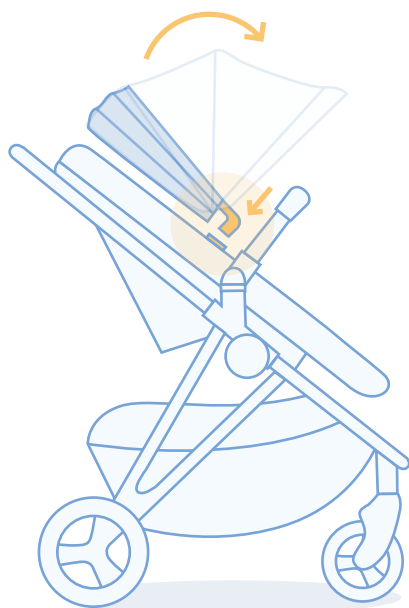

### Securing the canopy

Secure the elastic loops on the left and right sides of the canopy onto the hooks located on the seat frame.

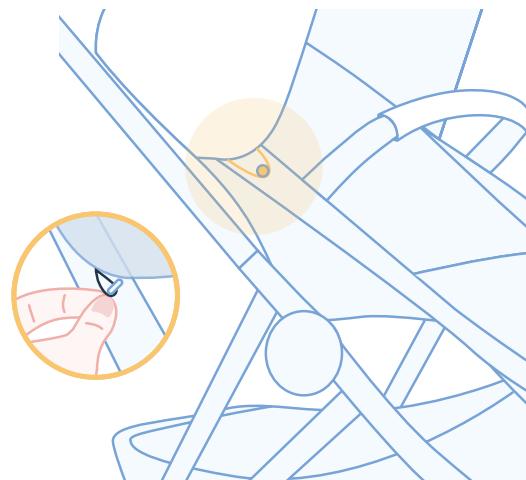

# 5

## Attach the child bar

Insert the pins located on the ends of the child bar into the housing located on the left / right side of the seat frame. The child bar “CLICKS” on both sides once it is in a fully locked position. To remove, press the white buttons located just below either side of the child bar.

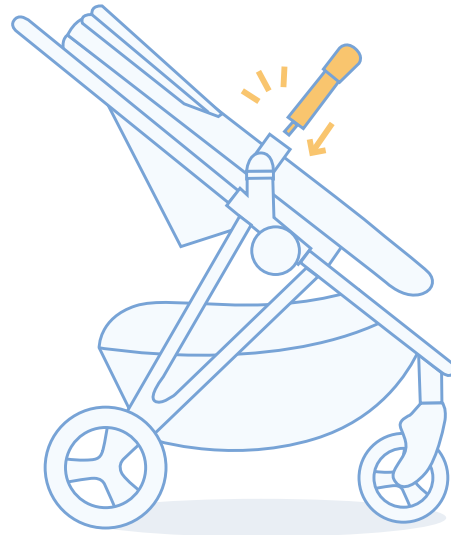

# Done!

**Great job! Look at you, mastering this whole parenting thing.**

Now grab the other guide to learn how everything works!

For a visual step-by-step guide,  reference our instructional video online.

Scan the QR code or visit [hellomockingbird.com/single-setup](https://hellomockingbird.com/single-setup).









mockingbird



# Your first stroll

**Mockingbird Single Stroller**

Here's everything you need to know to become a stroller pro

# Maneuvering

## One-touch rear brake

Apply downward pressure on bottom section of the brake lever located between the rear wheels. Confirm the brake is engaged by trying to push the stroller forward and backward. The wheels should not rotate. To release, apply light downward pressure on the top section of the brake lever rotating it forward.

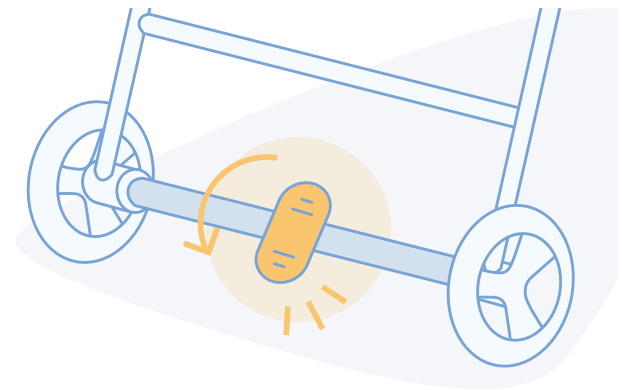

### Important!

Be sure to lock the brake before folding the stroller.



### Pro Tip

#### Locking the front wheels

The swivel lock on the front wheels prevents the wheels from rotating left & right while walking. This can help make for a smoother ride on tougher surfaces, like cobblestones or snow.

To lock, press downward on the white lever located on the top of the front wheel housing. Rotate the wheel until it “CLICKS” into a fully locked position. To unlock, press upward on the lever until it “CLICKS” into a fully unlocked position.

## Adjusting the handlebar

Press and hold the white buttons located on the left and right sides of the handlebar at the same time. While pressing, rotate the handlebar upward or downward into the desired position. The handle “CLICKS” on both sides once it is in a fully locked position.

**Important!**  
Always expect a little wiggle on any adjustable pieces, like the footrest and the handle

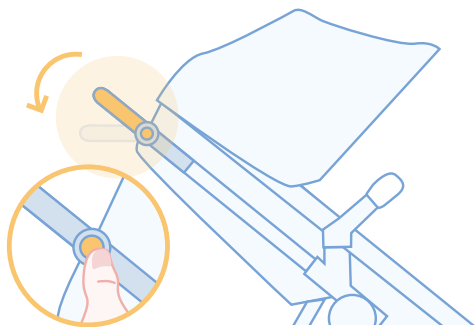

## Adjusting the footrest

Press and hold the white buttons located on the left and right sides of the footrest at the same time. While pressing, rotate the footrest upward or downward into the desired position.

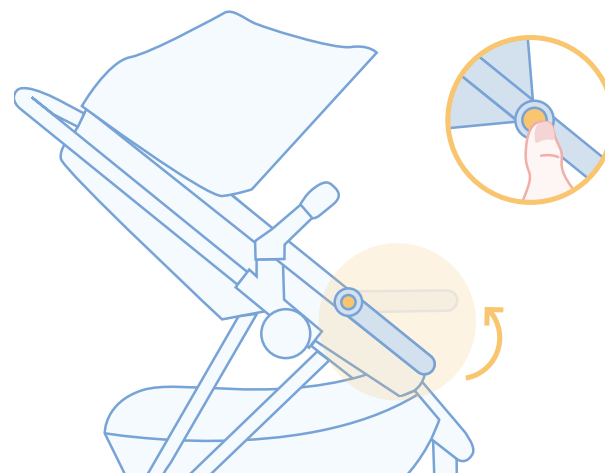

### Pro Tip

Our adjustable handlebar has six positions that make it workable for almost any sized parent. Kindergartners to NBA players welcome.

### Pro Tip

We've designed the footrest so that it can easily be rotated upward with one hand, but will not move downward when your child's feet are resting on it.

# Get style points with the one-hand fold

## Prepare to fold

Press the brake pedal down until it “CLICKS” into the locked position. Then close the canopy, position the stroller seat to an upright position, facing away from parent.

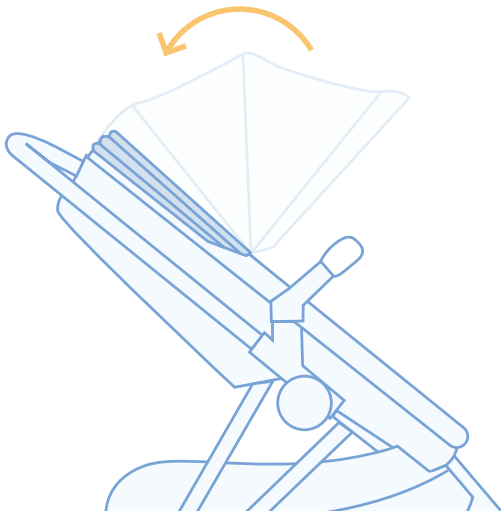

Slide the unlock tab with your thumb to the farthest left position and hold.

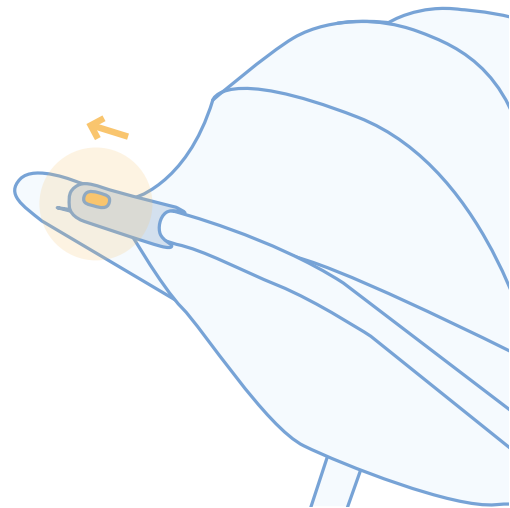

### Pro Tip

For the most compact fold adjust the stroller seat to the second most upright position.



### Important!

If you have the seat facing you, you need to reverse the seat to front facing before folding the stroller.

## Folding the stroller



While holding the unlock tab, squeeze the front button on the front of the handlebar inward until you feel the stroller begin to fold, and push downward on the handle.

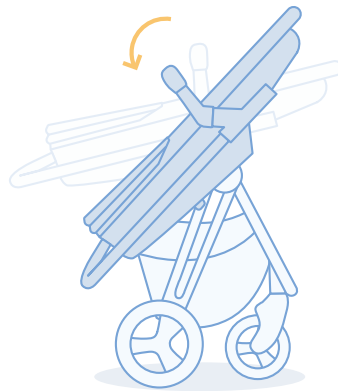

As the stroller folds down, let go of the handlebar and grab the child bar. Pull towards your body to complete the fold (don't worry about letting go for a second since the brake pedal is engaged, the stroller won't roll away from you).

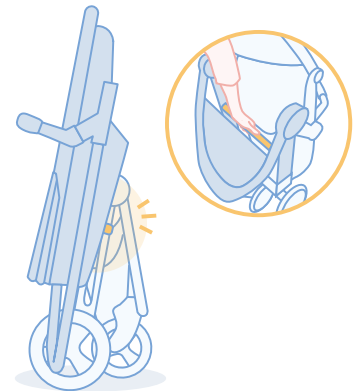

The stroller will fold until it is standing with the handlebar resting on the ground and the side latch “CLICKS”. For a more compact fold, adjust the footrest downward to a 90 degree angle after you fold. If you need to move it once it's folded, just pick it up by the crossbar and you'll be on your way!



### Pro Tip

Remove the child bar to make the stroller fit even better in your car. If needed, remove and store the seat first, and then store the frame separately.



# Secure your little one

## Adjust the shoulder straps

For easier access, open the shoulder pads and remove from the straps and re-attach after adjustment.

Slide the plastic stays up and down to adjust the height of the shoulder straps depending on your baby's size.

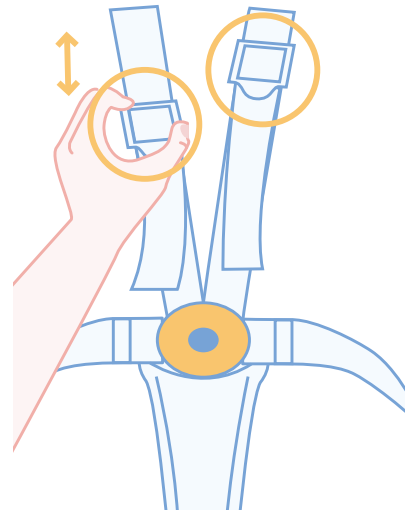
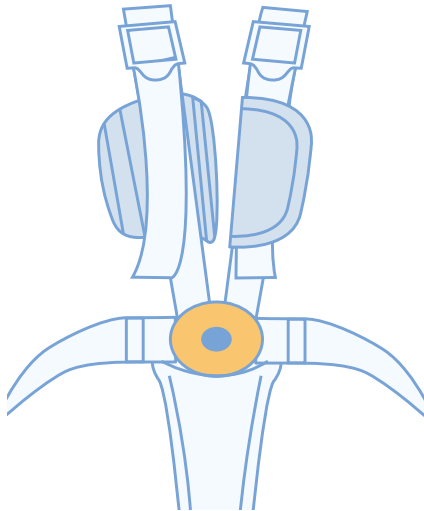

### Pro Tip

Your stroller is preset with the shoulder straps in the lowest position. As your child grows, adjusting the straps upward will make it more comfortable for them.

If you are using an Infant Insert, Footmuff, or Seat Liner, you may need to adjust the straps to the loosest position to make room for them.

## Place your child in the stroller

Position the crotch belt between their legs. Pull the shoulder straps over their arms and shoulders. Fasten both waist belts to the buckle on each side of the crotch belt, and make sure you hear a “CLICK” on both sides. Tighten each waist belt and shoulder strap so that the restraint system is snug.

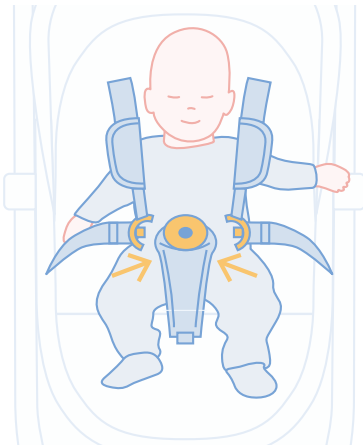

### Important!

Before placing your child in the stroller, make sure the brake is engaged, press the pedal down until it ‘CLICKS’ into the locked position.

## Tighten the straps

Feed the bottom end of the shoulder or waist strap through the plastic stay to form a loop and adjust the length. Once all straps are adjusted to the desired length, pull down on the ends of the shoulder straps to automatically adjust the shoulder strap height and ensure a snug fit for your little one.

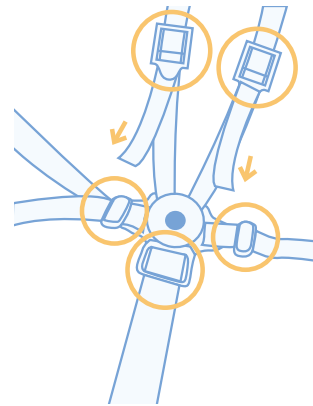

### Pro Tip

Another way to adjust the harness is by adjusting the crotch belt. When using the seat liner or footmuff, it is always best to loosen the crotch belt to the maximum length, and remove the crotch pad if additional room is needed.



# Growing with your baby

## For Infants

### Age 0 - 6 months

Before your baby develops the strength to properly support their own head & neck, we strongly advise you use at least one of these infant accessories to help make the Mockingbird Stroller safe and more comfortable for them. Here are the 3 options:

#### **Add the Mockingbird Infant Seat Insert**

We offer an infant insert that adapts the Mockingbird Stroller for extra security and support. With the stroller seat fully reclined, it creates a flatter seat position with extra head and neck support that allows your infant to safely enjoy the Mockingbird Stroller seat.

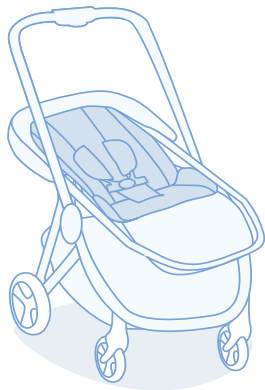

#### **Use the Mockingbird Bassinet in place of the stroller seat.**

We offer a Bassinet that attaches directly to your Mockingbird Stroller. And with our mattress pad and extendable sunshade, your little one will be cozy and comfy as they stroll in a lie-flat position.

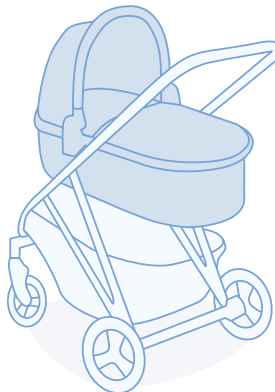

#### **Attach your infant car seat with our Car Seat Adapter**

With our Car Seat Adapter, you can go from car to stroller and back again without missing a beat. Our Car Seat Adapter makes the Mockingbird Stroller compatible with most commonly used car seats.

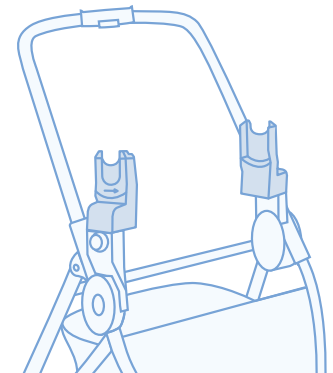

# For Toddlers

## Up to 42" or 50 pounds

Once your baby is older, you can make adjustments to maximize their comfort. The shoulder straps can be loosened, and you may want to lower the footrest to give your little one more leg room. You also might start using the seat facing away from parent more often, so your child can see the world!

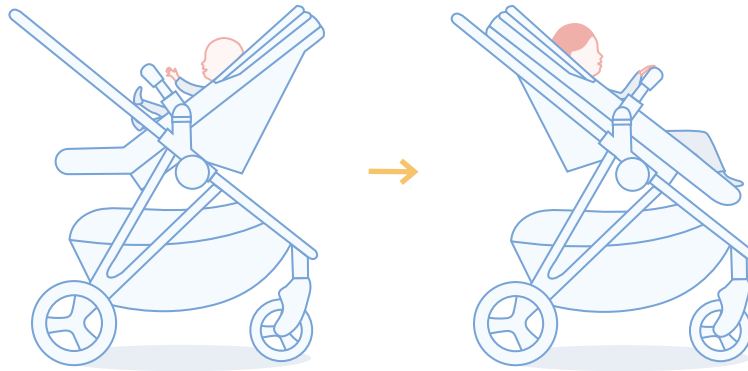

# For Multiples

## Add room for more with the Riding Board

The Mockingbird Single Stroller can be expanded with our Riding Board. You can accommodate a growing family, allowing your toddler to sit or stand comfortably while strolling.



**Infant + Toddler**



**Infant + Toddler**



**Toddler + Toddler**

# Sit back and relax

## Reclining the seat

Lift the recline latch located on the top center of the stroller seat and, while keeping it lifted, rotate the seat downward. To return to an upright position, lift the recline latch and rotate the seat upward.

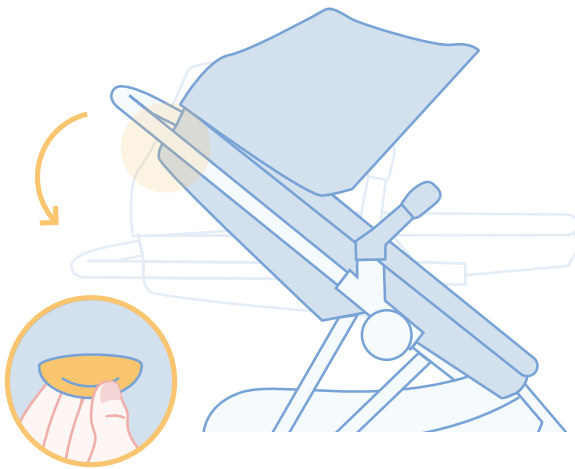

## Use the peek-a-boo window

Pull upward on window flap until it is in a fully opened position.

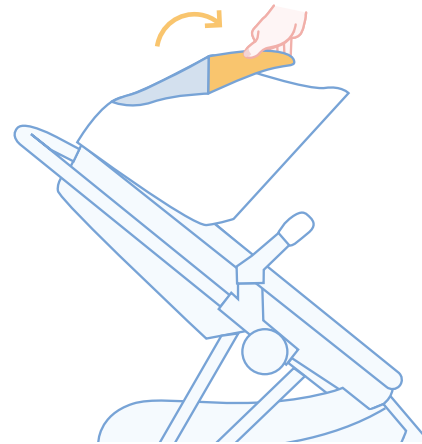

### Pro Tip

If you want to leave the peekaboo window ajar, you can also pull it forward, and the magnets on the window and the front of the canopy will keep it open.

# Beat the heat

## Extend the canopy

Locate the zipper on the back of the canopy and unzip. Pull on the canopy until it is fully extended. For even more coverage, pull forward on the visor panel located in the interior of the canopy. When finished tuck the visor back in.

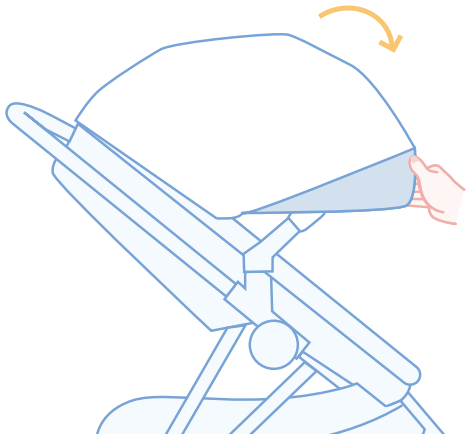

## Open the vent

Extend the canopy. Pull upward on the vent flap until it is in a fully opened position and keep your summer strolls easy breezy.

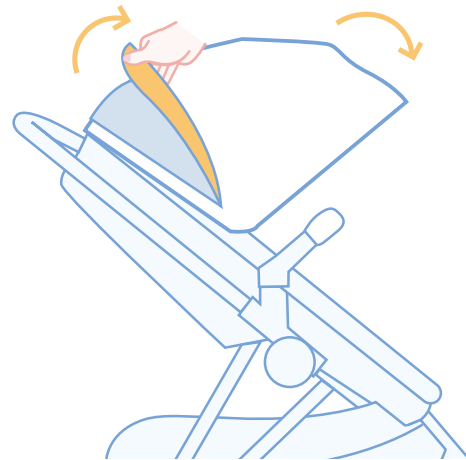

# When things get messy

## Removable basket

When you need a deeper clean, the storage basket can be removed. Open the five snaps at the rear of the basket and the two snaps at the front of the basket. Unzip the zippers at the left and right sides of the front of the basket, and you'll be able to completely remove it.

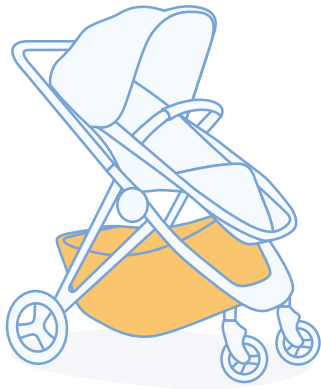

## Cleaning the footrest

The smart footrest is your secret weapon against toddler crumbs. Unzip the zipper along the exterior of the footrest, sweep the mess away, and zip it back up.

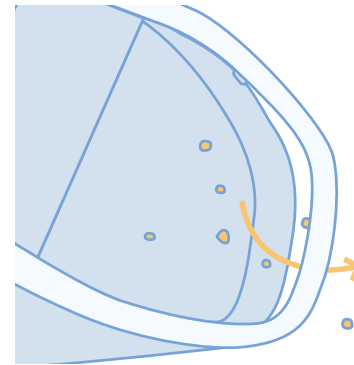

### Pro Tip

#### Secret storage compartment

Along the left side of the interior of the storage basket, you'll find an extra pocket. It's perfect for storing your sunshade or other small items.



### Pro Tip

#### Cell phone pocket

The backside of the stroller seat, just behind the child's headrest has a small pocket for cell phone storage, so you can stroll hands-free!

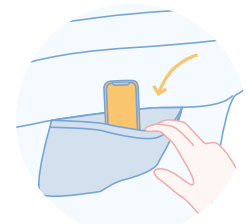

# Washing the stroller seat

## Remove the harness straps

Locate the plastic stays on the back and bottom of the stroller seat. Thread these through the stroller seat to remove the harness. The canopy and child bar should be removed as well.

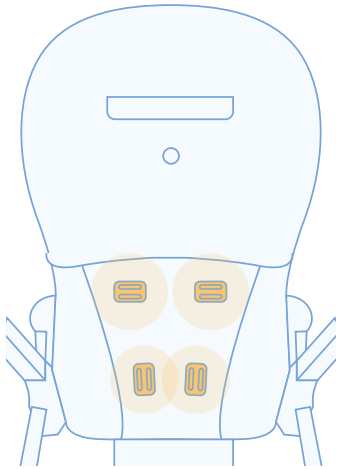

## Remove the seat fabric

Unzip the footrest and undo the velcro attachments on the sides and bottom of the seat. Pull the seat fabric up and over the recline latch to fully remove the seat fabric from the seat frame.

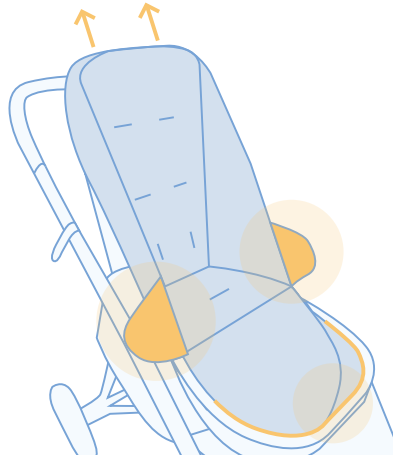

## Remove the seat boards

Flip the fabric on the headrest over to expose the velcro opening. Undo the velcro and pull out the backrest board. Locate the velcro opening on the bottom of the seat, undo and pull out the seat board. You are now ready to machine wash your stroller seat. Wash in cold water and air dry only.

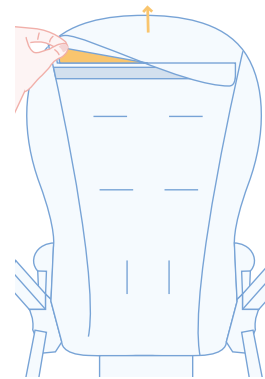

Back of the stroller seat

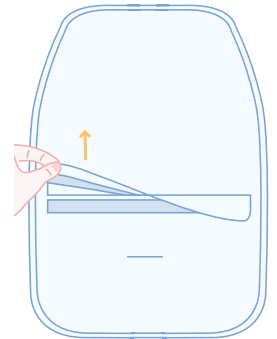

Bottom of the stroller seat



### Pro Tip

For smaller messes, the stroller seat can be spot cleaned with a damp cloth.



## When things get (really) messy

### Cleaning the fabric



Hand wash with a damp cloth



Air dry



Do not bleach

### Cleaning the frame and plastic



Use mild cleaning solution



Use warm water on a sponge or cloth

### Cleaning the Stroller Seat



Machine wash in cold water



Do not bleach



Air dry



Do not iron or dry clean

# Accessories for all of life's adventures

Find these items and more, at [hellomockingbird.com](https://hellomockingbird.com)



**Snack**

**Cup Holder & Snack Tray**



**Cold**

**Footmuff**



**Explore**

**Riding Board**



**Organization**

**Parent Organizer**



# You're now ready to roll with confidence!

Our Customer Experience Specialists are on hand to help you set up and use your stroller, understand its features, and determine which accessories are right for you.



## Contact us

[hellomockingbird.com/contact](https://hellomockingbird.com/contact)



## Call or text us

646.933.1290



## Follow us

@hello\_mockingbird

