



mockingbird



Let's get rolling

Mockingbird Single-to-Double Stroller

Instruction Manual and User Guide

Scan the QR code for a step-by-step video tutorial on setting up and using your Mockingbird Stroller.



Warning

Please follow all of these instructions to ensure the safety of your children. Keep these instructions for future reference. Failure to follow these instructions could result in serious injury or death.

Avoid serious injury from falling or sliding out. Always ensure that the child is properly positioned by using the safety harness according to these instructions.

Choking Hazard

Adult assembly required because of small parts. Keep (assembly parts) out of reach of children under 3 years.

Caution

- Make sure the stroller is fully erect and latched in the open and locked position before allowing children near the Stroller.
- Make sure all body parts are clear of the stroller when folding and unfolding.
- Never leave children unattended.
- Never use the stroller on stairways or escalators.
- Never use the stroller with roller skates or in-line skates.
- Stroller is for walking speed only. Never run with the stroller.
- Never allow the stroller to be used as a toy.
- NEVER use with accessories or replacement parts not approved by Mockingbird for use with this product.
- The buckle and buckle clips contain magnets. If your child has a medical condition that prohibits the use of magnets near the child, do not use the stroller. Contact Mockingbird to arrange a mechanical harness and buckle solution. Be mindful of the possible interaction of magnets in buckles and certain electronic devices.
- Maximum user weight in single stroller seat 50lbs.
- Maximum user weight per seat when using stroller with a 2nd Seat Kit 45lbs. Maximum user height in the stroller seat 42 inches (107 cm).
- The maximum weight that can be carried in the lower basket is 25 lbs (11.3 kg). Placing excessive weight in the unit or on the unit (e.g., purses, shopping bags, parcels, diaper bags, or accessory items) may change the balance of the stroller and cause hazardous/unstable conditions.
- The maximum weight that can be stored in any storage pocket is 1 lb.
- If using this Stroller with the Mockingbird 2nd Seat Kit accessory, please refer to the 2nd Seat Kit Instruction Manual. When attaching a second seat, always load the upper seat first (before the lower seat). Unload child in the lower seat first. To prevent tipping, always engage the brake before loading and unloading.
- Never use the stroller if it shows any signs of deterioration or excessive wear and tear. If any such deterioration or excessive wear and tear is observed, please contact the Mockingbird Customer Experience Team at hellomockingbird.com/contact or text us at 646.933.1290 (US).

Table of Contents

Instruction Manual

- 2 What's Included**
- 3 Open the Frame**
- 4 Attach the wheels**
- 5 Attach the stroller seat**
- 6 Attach the canopy**
- 7 Attach the child bar**

User Guide

- 10 Maneuvering and Adjusting**
 - On-touch rear brake
 - Adjusting the handlebar
 - Reclining the seat
 - Adjusting the footrest
- 12 One-hand fold**
 - Prepare to fold
 - Folding the stroller
- 14 Secure your little one**
 - Adjust the shoulder straps
 - Fasten the magnetic buckle
 - Tighten the straps
- 16 Growing with your baby**
 - Infants
 - Graduating to the Stroller Seat
 - Multiples
- 18 Canopy Comfort**
 - Extend the canopy
 - Adjust the canopy height
- 19 Beat the heat**
 - Reverse the seat liner
 - Extend the sunshade
- 20 Storage for all**
 - Back seat pockets
 - Stroller seat slip pocket
- 21 When things get messy**
 - Removable basket
 - Cleaning the footrest
 - Removable seat liner
- 22 Cleaning and Maintenance**





Watch our instructional
video for a step-by-step
tutorial here.

Instruction Manual

Let's get your stroller set up!

First, unpack the box and make sure you've got everything

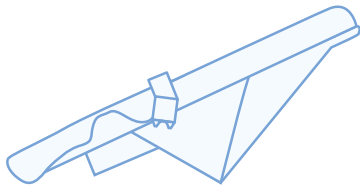

Stroller seat
(with sunshade)

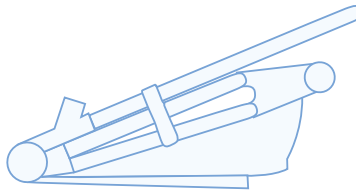

Stroller frame

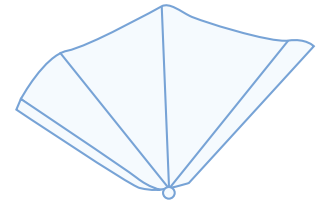

Extendable Canopy



Child bar

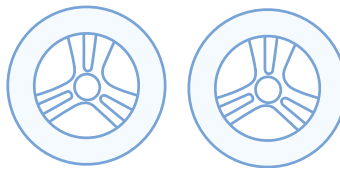

Rear wheels

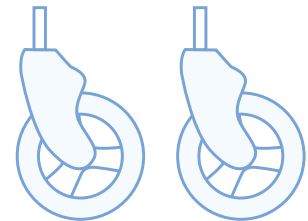

Lock & swivel front wheels



Storage Bag

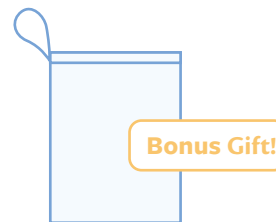

Wet Bag

1

Open the frame

Lift up the latch

On the right side of the stroller frame, lift up on the latch to open the frame.

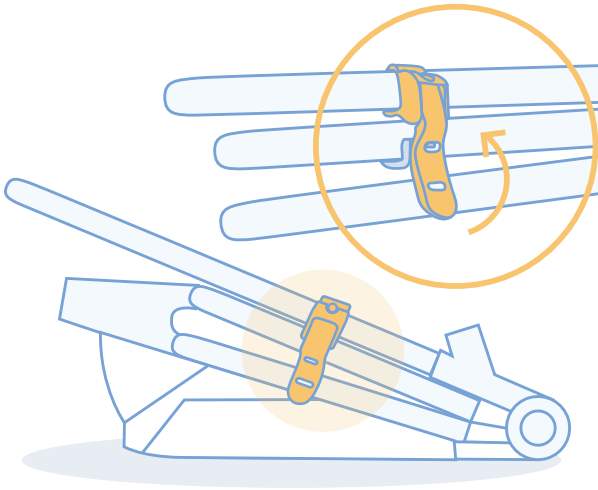

Open the frame

Lift up on the stroller handle with both hands until the stroller frame is in a fully opened and locked position. When the stroller is fully opened, you will hear a “CLICK”.

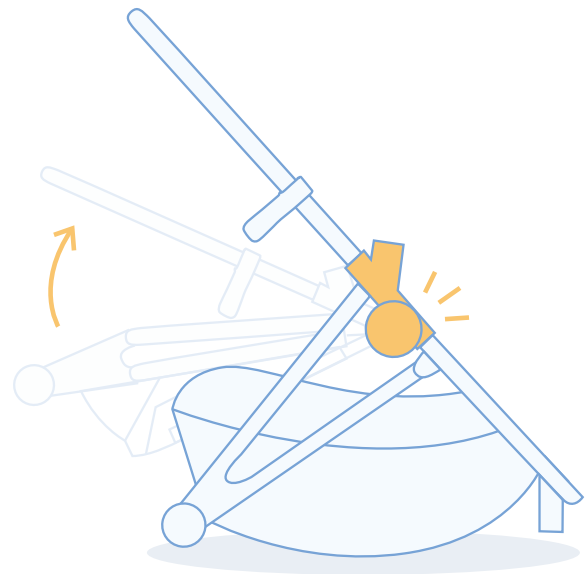

2

Attach the wheels

Attaching the front wheels

Push the front wheel post into the wheel housing until it “CLICKS” into a fully locked position. Pull on the wheel to confirm it is attached. To remove, press the metal button located on the back of the wheel housing and push inward.

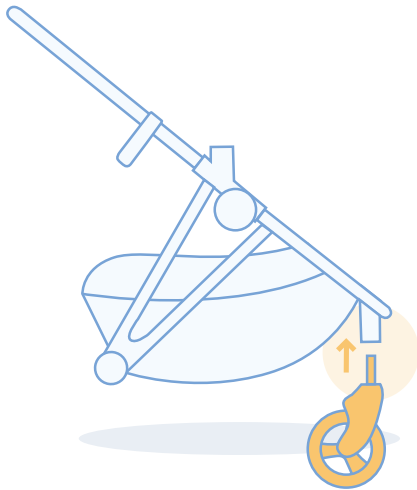

Attaching the rear wheels

Push the rear wheel post into the wheel housing.

Pull on the wheel to confirm it is attached. To remove, lift the white levers located on the back of the wheel housing and pull the wheel outward.

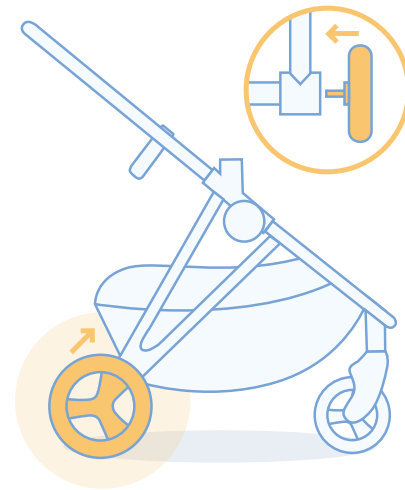

Pro Tip

Before attaching the front wheels, make sure the stroller is in a fully open position.



3

Attach the stroller seat

Place the stroller seat into the right and left joints until it “CLICKS” into a fully locked position. Pull up on each side of the seat to confirm attachment. Press the white buttons located on both sides of the stroller frame and lift stroller seat upward to fully remove.

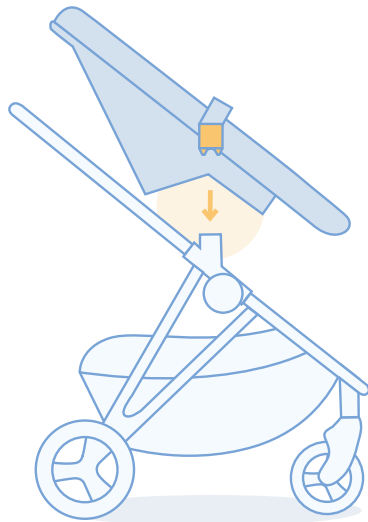

Front facing seat

Child faces away from parent

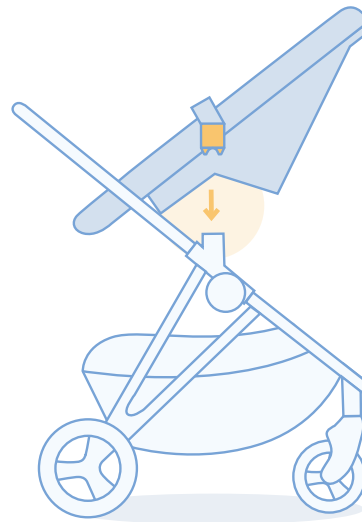

Rear facing seat

Child faces parent



Important!

Seat must be front facing (away from parent) to fold the stroller.

4

Attach the canopy

Attaching the canopy

Place the back of the canopy over the top of the stroller seat above the recline latch. Snap the right and left sides of the canopy to the stroller frame on top of the white Mockingbird logos. Slide the canopy down the frame to put it in the standard position. The canopy is height-adjustable and can be adjusted upwards to give your little one more room as they grow older.

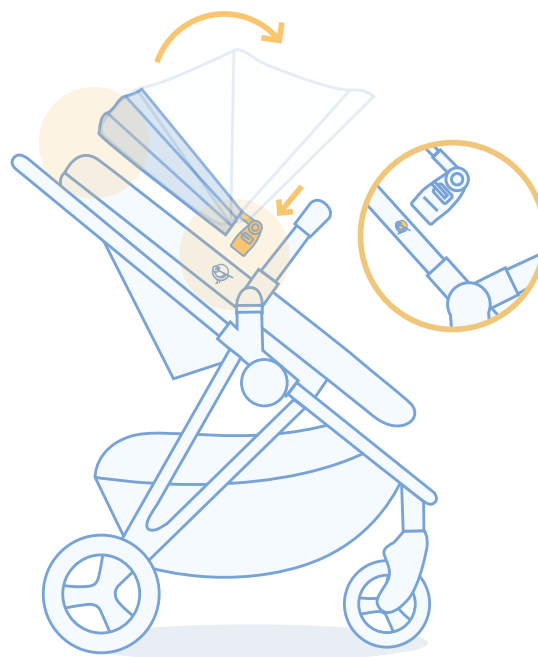

Pro Tip

The canopy has two adjustable positions to fit your little one just right. See page 18 for more tips about adjusting the canopy height.

5

Attach the child bar

Insert the pins located on the ends of the child bar into the housing located on the left / right side of the seat frame. The child bar “CLICKS” on both sides once it is in a fully locked position. To remove, press the white buttons located just below either side of the child bar.







User Guide

Great job! Look at you, mastering this set up.

Read on to learn how everything works!

Maneuvering and Adjusting

One-touch rear brake

Apply downward pressure on bottom section of the brake lever located between the rear wheels. Confirm the brake is engaged by trying to push the stroller forward and backward. The wheels should not rotate. To release, apply light downward pressure on the top section of the brake lever rotating it forward.

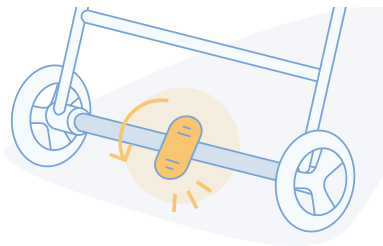

Pro Tip

Locking the front wheels

The swivel lock on the front wheels prevents the wheels from rotating left & right while walking. This can help make for a smoother ride on tougher surfaces, like cobblestones or snow.

To lock, press downward on the white lever located on the top of the front wheel housing. Rotate the wheel until it “CLICKS” into a fully locked position. To unlock, press upward on the lever until it “CLICKS” into a fully unlocked position.

Adjusting the handlebar

Press and hold the white buttons located on the left and right sides of the handlebar at the same time. While pressing, rotate the handlebar upward or downward into the desired position. The handle “CLICKS” on both sides once it is in a fully locked position.



Important!

Always expect a little wiggle on any adjustable pieces, like the footrest and the handlebar.

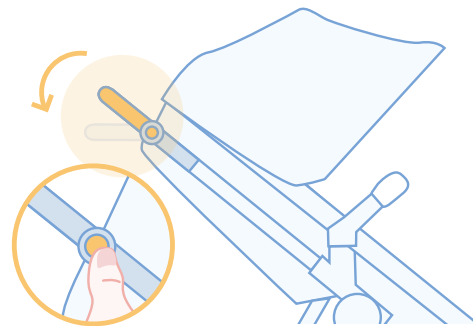

Pro Tip

Our adjustable handlebar has six positions that make it workable for parents of almost any height. Kindergartners to NBA players welcome.



Reclining the seat

Lift the recline latch located on the back of the stroller seat and, while keeping it lifted, rotate the seat downward. To return to an upright position, lift the recline latch and rotate the seat upward.

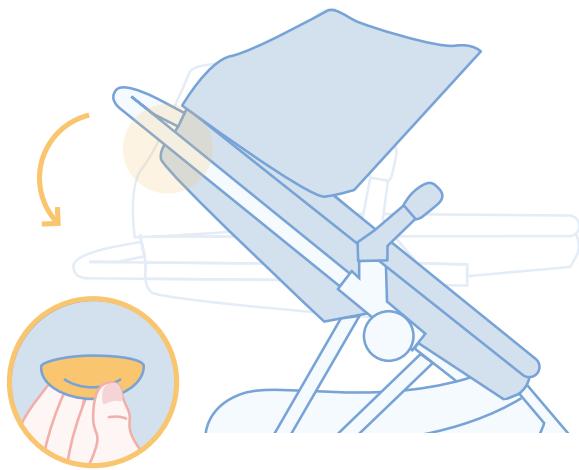

Adjusting the footrest

Press and hold the white buttons located on the left and right sides of the footrest at the same time. While pressing, rotate the footrest upward or downward into the desired position.

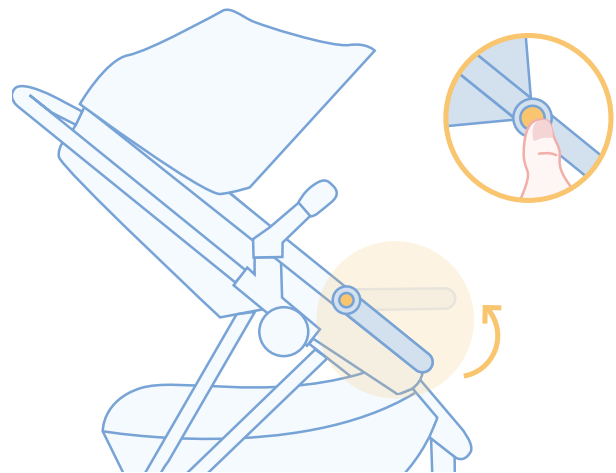

Pro Tip

We've designed the footrest so that it can easily be rotated upward with one hand, but will not move downward when your child's feet are resting on it.

Get style points with the one-hand fold

Prepare to fold

Press the brake pedal down until it “CLICKS” into the locked position. Then close the canopy, position the stroller seat in an upright position, facing away from parent.

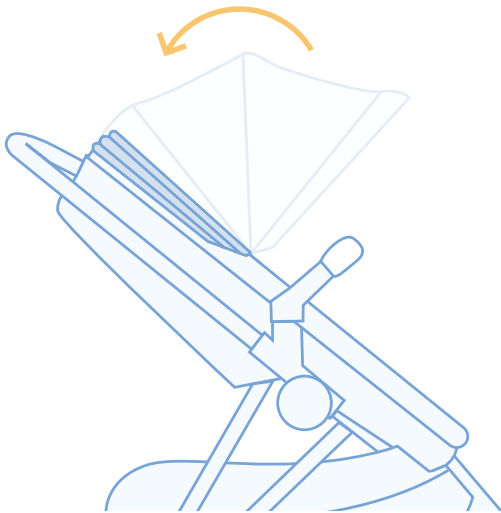

Slide the unlock tab with your thumb to the farthest left position and hold.

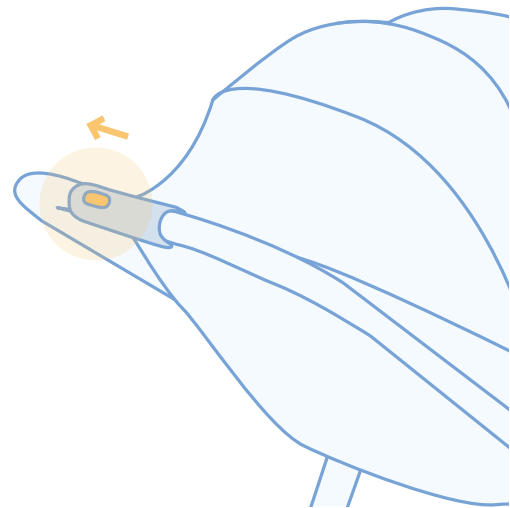

Important!

If you have the seat facing you, you need to reverse the seat to front facing (facing away from the parent) before folding the stroller.

Folding the stroller



While holding the unlock tab, squeeze the front button on the front of the handlebar inward until you feel the stroller begin to fold, and push downward on the handle.

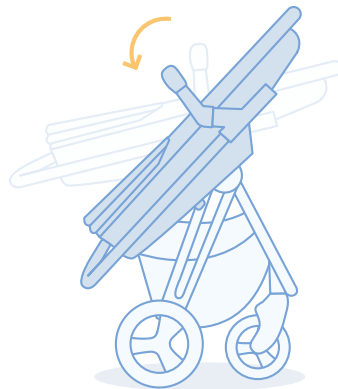

As the stroller folds down, let go of the handlebar and grab the child bar. Pull towards your body to complete the fold (don't worry about letting go for a second since the brake pedal is engaged, the stroller won't roll away from you).

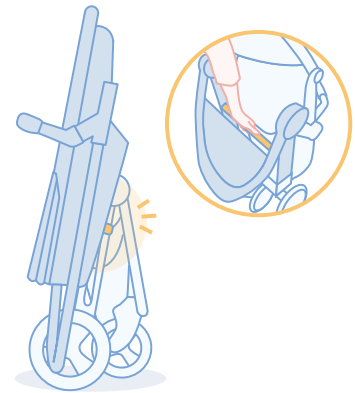

The stroller will fold until it is standing with the handlebar resting on the ground and the side latch “CLICKS”. For a more compact fold, adjust the footrest downward to a 90 degree angle after you fold. If you need to move it once it's folded, just pick it up by the crossbar and you'll be on your way!



Pro Tip

Remove the child bar to make the stroller fit in your car even more compactly. If needed, remove and store the seat first, and then store the frame separately.

Secure your little one

Adjust the shoulder straps

For easier access to the plastic stays, open the shoulder pads and remove them from the straps before making adjustments. Reattach the pads once adjustment is complete.

Slide the plastic stays up and down to adjust the height of the shoulder straps depending on your baby's size.

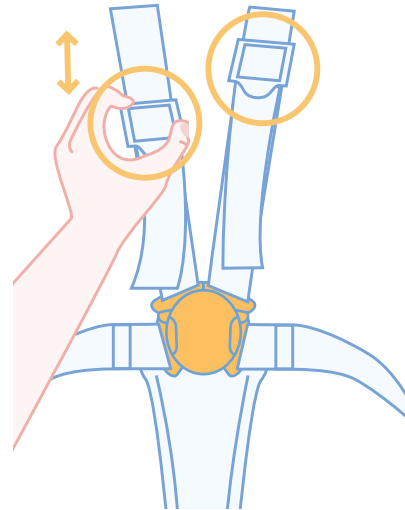
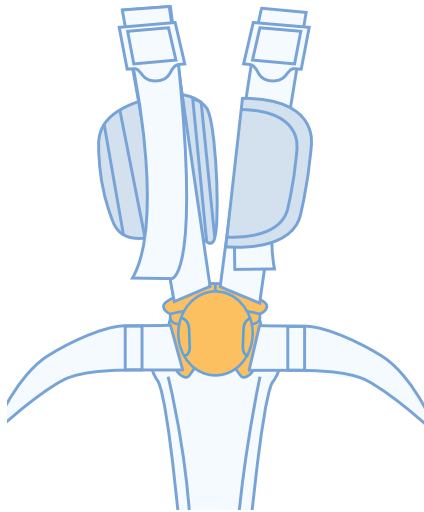

Pro Tip

Your stroller is preset with the shoulder straps in the lowest position. As your child grows, adjusting the straps upward will make it more comfortable for them.

If you are using an Infant Insert, Footmuff, or Seat Liner, you may need to adjust the straps to the loosest position to make room for them.



Fasten the magnetic buckle

Position the crotch belt between your little one's legs. Pull the shoulder straps over their arms and shoulders. Fasten the magnetic strap clips together by aligning the smaller clip over the larger clip until you hear an audible "CLICK". Then, snap the magnetic buckle over the strap clips until you hear an audible "CLICK". Gently tug the straps to confirm they're securely fastened.

For Un-Buckling

Loosen the straps, then squeeze the side buttons on the magnetic buckle and pull it away from the clips. Hold the top edge of the smaller clip and lift it toward you to separate the clips and undo the buckle.

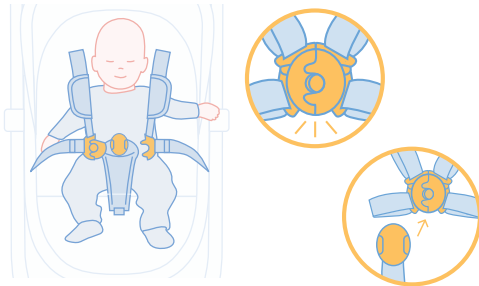

Important!

Before placing your child in the stroller, make sure the brake is engaged, press the pedal down until it 'CLICKS' into the locked position.

Tighten the straps

Feed the bottom end of the shoulder or waist strap through the plastic stay to form a loop and adjust the length. Once all straps are adjusted to the desired length, pull down on the ends of the shoulder straps to automatically adjust the shoulder strap height and ensure a snug fit for your little one.

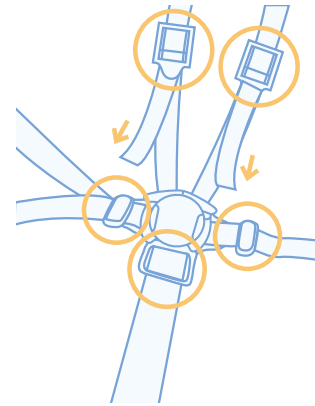

Pro Tip

Another way to adjust the harness is by adjusting the crotch belt. When using the seat liner or footmuff, it is always best to loosen the crotch belt to the maximum length, and remove the crotch pad if additional room is needed.

Growing with your baby

Infants

Age 0 - 3 months

Before your baby develops the strength to properly support their own head & neck, we strongly advise you use at least one of these infant accessories to help make the Mockingbird Stroller safe and more comfortable for them. Here are the 3 options:

Add the Mockingbird Infant Seat Insert

Our Infant Seat Insert adapts the Mockingbird Stroller for extra security and support. With the seat fully reclined, the insert creates a flatter surface with extra head and neck support. Remove the Seat Liner before installing.

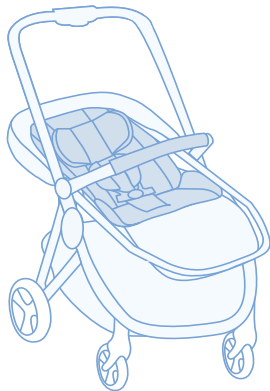

Use the Mockingbird Bassinet in place of the stroller seat.

Our Bassinet attaches directly to your Mockingbird Stroller. With our mattress pad, extendable canopy and ventilation panels, your little one will be cozy and comfy as they stroll in a totally lie-flat position.

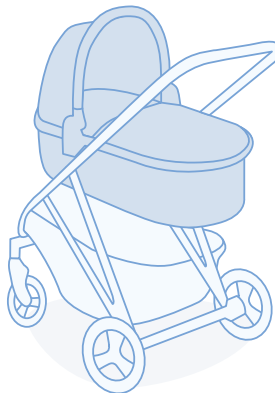

Attach your infant car seat with our Car Seat Adapter

With our Car Seat Adapter, you can go from car to stroller and back again without missing a beat. Our Car Seat Adapter makes the Mockingbird Stroller compatible with most commonly used car seats.

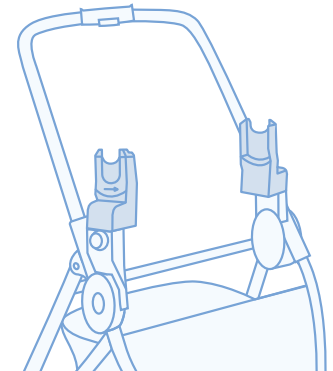

Graduating to the Stroller Seat

Up to 42" or 50 pounds

Once your little one develops head and neck control, they can start using the stroller seat reclined. They can use the seat upright when they can sit up unassisted. You can make adjustments to the seat to maximize their comfort as they grow (or for whatever the day brings!). Start with your little one facing you in the earlier months. As they grow, you can loosen the shoulder straps, move the crotch belt forward, and adjust the canopy up to create more headroom (see page 18). When they become curious to explore the world around them, reverse the seat to face out.

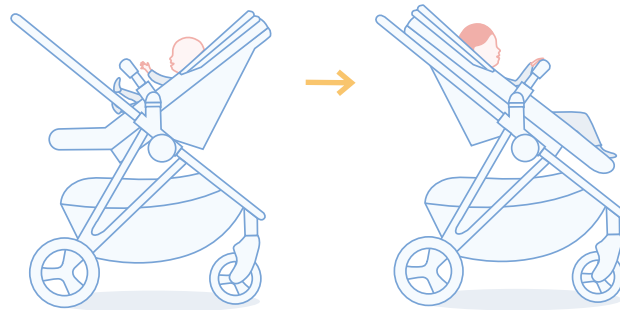

Multiples

Add room for more with the 2nd Seat Kit and Riding Board

The Mockingbird Single-to-Double Stroller can be expanded with our 2nd Seat Kit and/or Riding Board. You can accommodate a growing family through every stage, including twins!



Infant + Infant



Infant + Toddler

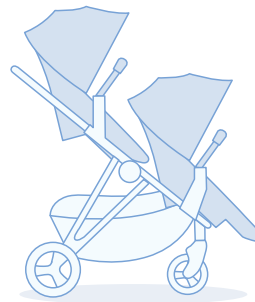

Toddler + Toddler



Squad

Canopy Comfort

Extend the canopy

The extendable canopy has two extendable panels for extra sun protection. Pull out the front visor located in the interior canopy. For more coverage, find and unzip the zipper at the back of the canopy to extend the back panel. Pull back the panel to reveal a hidden mesh section for added airflow on warm days.

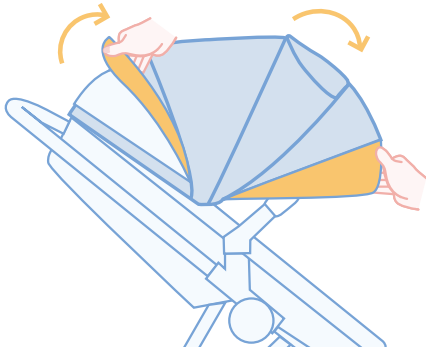

Adjust the canopy height

To create more headroom for your little one, pull up on the top center of the canopy near the recline latch. To return it to the standard height, press down on the same spot. Be sure to listen for a “CLICK” on both sides when adjusting up or down to ensure it’s securely in place.

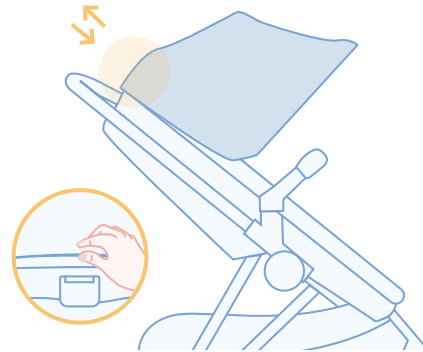

Pro Tip

Peek-a-boo window

Lift the flap on the magnetic peek-a-boo window for quiet check-ins. To keep the window open, pull it forward and the magnets on the flap and canopy front will hold it in place.

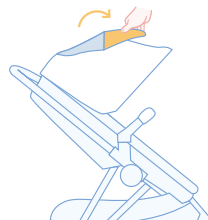

Beat the heat

Reverse the seat liner

The seat liner is reversible to provide comfort year-round. The standard side is soft yet durable, perfect for everyday use. As the weather gets warmer, simply flip the liner to the breathable mesh side to increase airflow and help keep your little one cool.

To remove the seat liner, unbuckle the harness and disconnect both waist straps from the shoulder straps by pulling them out and away from the shoulder straps. You should now have five separate straps. Undo the toggles at the top of the seat and pull the liner through the harness straps. Flip the liner to the desired side, rethread the harness straps, and re-secure the toggles. Slide the waist strap clips back into the shoulder strap clips to reconnect the harness.

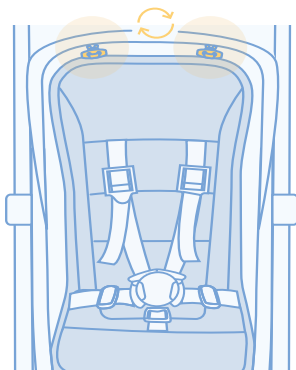

Extend the sunshade

The integrated sunshade is conveniently stored under the seat. For extra leg coverage on sunny days, pull the sunshade out from the under-seat pocket and stretch it up and over the footrest while in the lowest position. Attach the velcro straps to the child bar, and button the sides of the sunshade to the stroller frame. Once attached, gently tug on the sunshade to ensure it is securely in place. When you're finished, simply undo the attachments, fold it up, and store it under the seat.

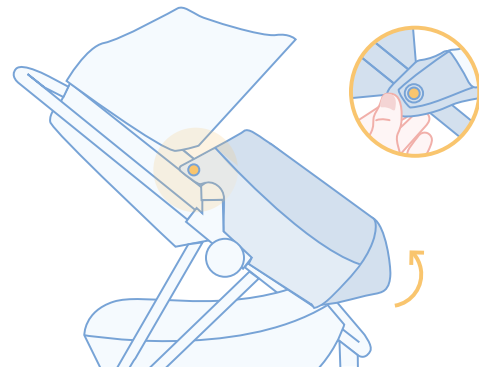

Storage for all

Back seat pockets

Keep all your essentials within arm's reach with two convenient storage pockets.

The top pocket is perfect for keeping valuables like your phone, wallet, or keys tucked away safely.

The bottom pocket is great for stashing parenting essentials on the go like wipes, sunscreen, or an extra set of clothes.

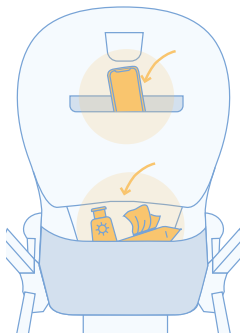

Stroller seat slip pockets

Keep your kiddo's essentials within easy reach too, thanks to the two elastic slip pockets on either side of the stroller seat. They're perfect for storing small toys, a pacifier, or a snack!

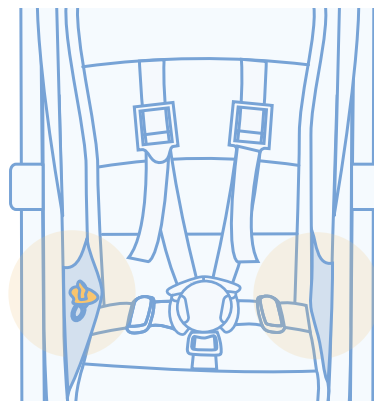

Pro Tip

Secret storage compartment

Along the left side of the interior of the storage basket, you'll find an extra pocket. It's perfect for storing your small items.



When things get messy

Removable basket

When you need a deeper clean, the storage basket can be removed. Open the five snaps at the rear of the basket and the two snaps at the front of the basket. Unzip the zippers at the left and right sides of the front of the basket, and you'll be able to completely remove it.

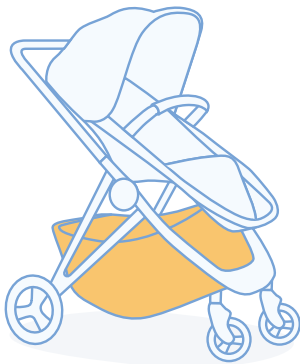

Cleaning the footrest

The smart footrest is your secret weapon against toddler crumbs. Unzip the zipper along the exterior of the footrest, sweep the mess away, and zip it back up.

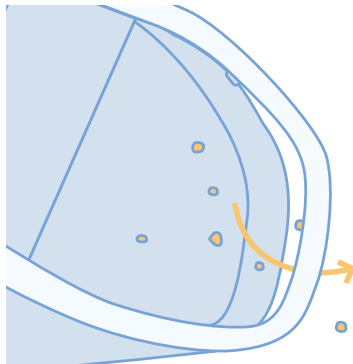

Removable seat liner

For a deep clean, the seat liner is machine washable. See page 19 for more tips about removing the seat liner.

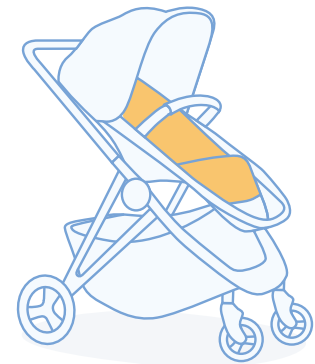

Cleaning and Maintenance

When things get (really) messy

Cleaning the fabric



Hand wash with a damp cloth



Air dry



Do not bleach

Cleaning the frame and plastic



Use mild cleaning solution



Use warm water on a sponge or cloth

Cleaning the Seat Liner



Machine wash in cold water



Do not bleach



Air dry



Do not iron or dry clean

Accessories for all of life's situations

Find these items at hellomockingbird.com/accessories



Snack

Cup Holder & Snack Tray



Cold

Footmuff

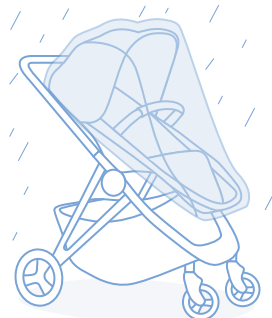

Explore

Rain Cover



Organization

Parent Organizer

You're now ready to roll with confidence!

Our Customer Experience Specialists are on hand to help you set up your stroller, understand it's features, and determine which accessories are right for you.



Contact us

hellomockingbird.com/contact



Follow us

[@hello_mockingbird](https://www.instagram.com/hello_mockingbird)

